

IVI8 Molding

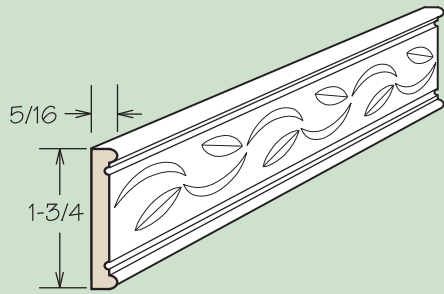

IVI8

- Not available in Maple Frost or Oak Frost.
- Ivy insert molding.
- 8 feet long.

LBM8 Molding

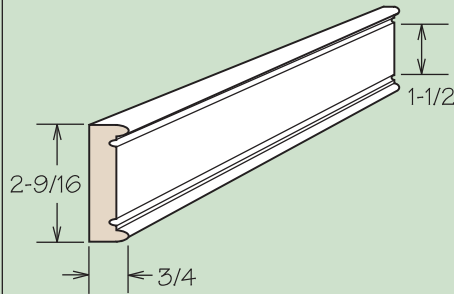

LBM8

- Library molding.
- 8 feet long.
- May be used with EDM8 for accent.

LR8 Molding

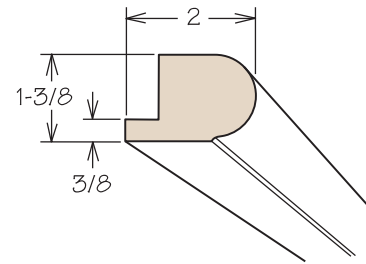

LR8 WD

- Light rail molding.
- Eight feet long.
- White door styles are MDF wrapped with 12 mil. Thermo Foil
- LR8 WD is MDF with wood veneer stained to match cabinet exterior.

OCM8 Molding

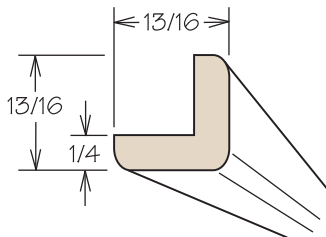

OCM8

- Outside corner molding.
- Eight feet long.
- Solid hardwood stained to match cabinet exterior. White door styles are MDF wrapped with 12 mil. Thermo Foil.

PRM6 Molding

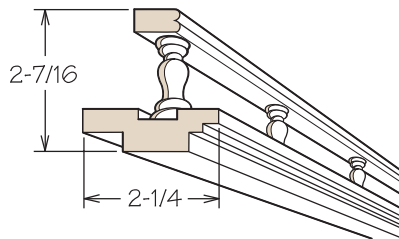

PRM6 WD

- Decorative plate rail molding.
- 6 feet long.

QM8 Molding

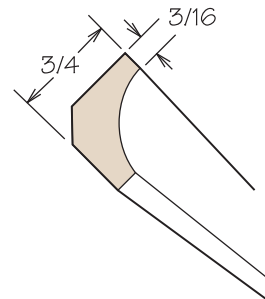

QM8 WD

- Inside corner trim.
- 8 feet long.

QR8 Molding

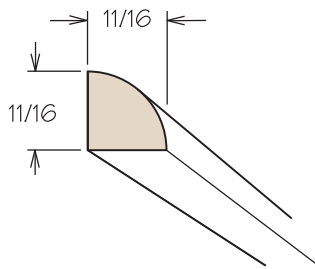

QR8

- Quarter Round.
- 8 feet long.

RM8 Molding

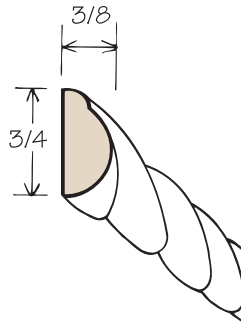

RM8 WD

- Rope molding.
- Eight feet long.
- Solid hardwood stained to match cabinet exterior. White door styles are MDF wrapped with 12 mil Thermo Foil.

SCM8 Molding

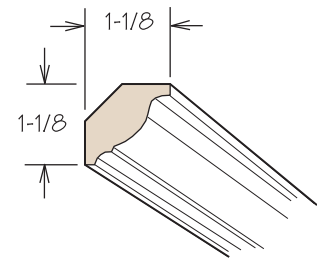

SCM8 WD

- Soffit molding.
- Eight feet long.
- Solid hardwood stained to match cabinet exterior. White door styles are MDF wrapped with 12 mil Thermo Foil.

TBM8 Molding

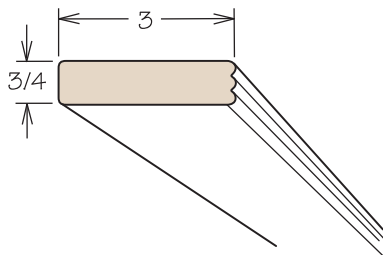

TBM8

- Triple bead molding.
- 8 feet long.

TLR8 Molding

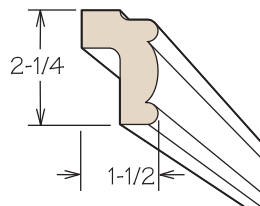

TLR8

- Traditional light rail molding.
- Eight feet long.
- Solid hardwood stained to match cabinet exterior. White door styles are MDF core with 12 mil Thermo Foil.

UM8 Molding

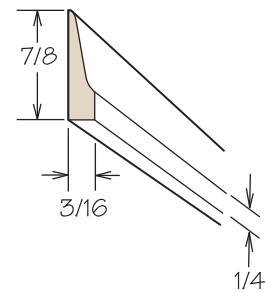

UM8 WD

- Straight trim.
- 8 feet long.

Traditional Split Post

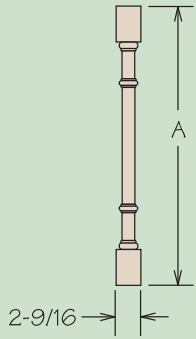

PA15T
PA18T
PA24T
PA30T
PA36T
PA42T

- **Not available in Maple Frost or Oak Frost.**
- Made from solid Oak, Maple, Hickory or Cherry.
- PA15T = 15-1/8"
- PA18T = 18-1/8"
- PA24T = 24-1/2"
- PA30T = 30-1/2"
- PA36T = 36-1/8"
- PA42T = 42-1/8"
- 3/4" thick.

Accent Turned Leg

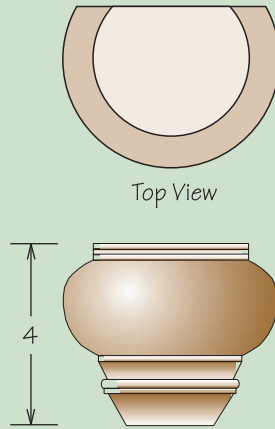

ATL

- **Not available in Maple Frost or Oak Frost.**
- Accent Turned Leg.
- Designed as Toekick Accent.
- Oak used for Hickory.
- Trimmable.

Base Turned Leg

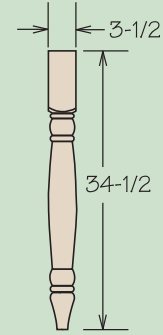

BTL

- **Not available in Maple Frost or Oak Frost.**
- Made from solid Oak, Maple, Hickory or Cherry.
- Trimmable to 28-1/2" high.
- 3-1/2" x 3-1/2" square.

French Carved Leg

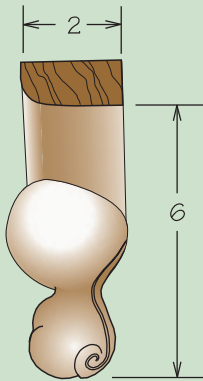

FCL

- **Not available in Maple Frost or Oak Frost.**
- French Carved Leg.
- Maple used for Hickory and Oak.
- Trimmable.

Carved Corbel

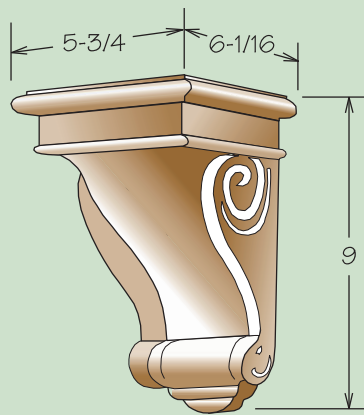

SC9

- **Not available in Maple Frost or Oak Frost.**
- Carved solid hardwood.
- Mounting hardware included.

Shell Applique

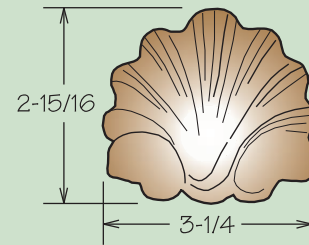

LSO

- **Not available in Maple Frost or Oak Frost.**
- Carved solid hardwood.
- Beech used for Hickory and Oak.
- Attach using small brad.

Shell Overlay Applique

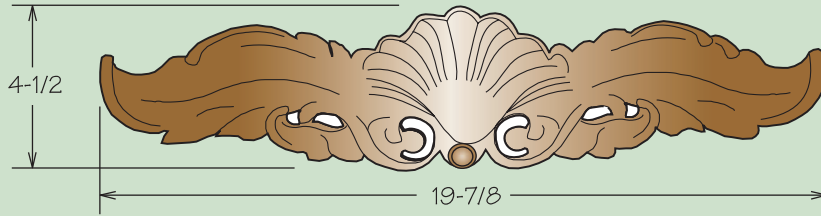

SIA

- Not available in Maple Frost or Oak Frost.
- Carved solid hardwood.
- Beech used for Hickory and Oak.
- Attach using small brad.

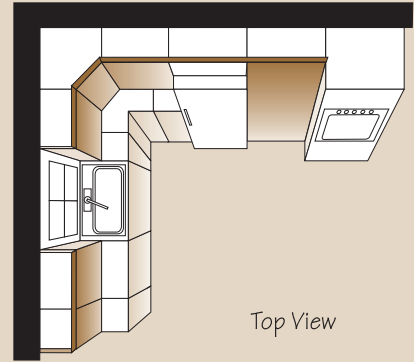

Top View

Installation Items

Preglued Edgbanding

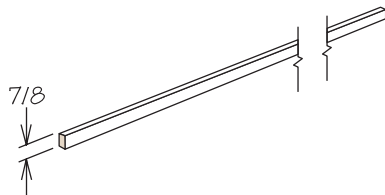

EB78

- Available in white only.
- 7/8" wide and 50 feet long.
- Cut to fit.
- Applies with a household iron.

20/20 Page
P-1

Autograph Page
47

Screws & Screw Cover Caps

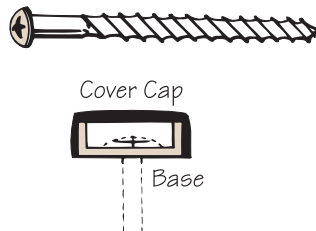

Screws
Box of 100

Screw
Cover Caps
Bag of 50

- Box contains 100 phillips "panhead" installation screws.
- Screw head can be concealed with a cover cap.
- 2-1/2" long.
- Poly bag contains 50 cover caps and bases.
- Use to conceal head of installation screw.
- Cover caps come in almond color.

Shelf Rests

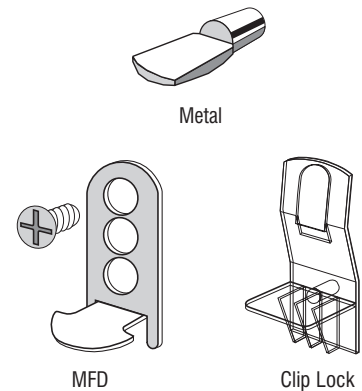

Shelf Rest Metal (Wall Cabinets)
4 pk. or 12 pk.

Shelf Rest MFD 8PK
(MFD Cabinets)

Clip Lock Shelf 4PK
(Base Cabinets)

- Metal rests are chrome plated steel.

Stain - 11 oz. Spray Can

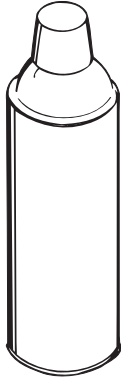

SPRAY STAIN

- 11 ounce aerosol spray can.
- Stain to match color style.
- Clear spray stain for use as top coat with stains.
- Consult price book for availability.

Matching Stain Kits



STAIN
STAIN CLEAR TOP COAT

Finish Color	Kit Contents
Oak Honey Oak Natural Maple Natural Hickory Natural	<ul style="list-style-type: none"> ● 1 pint stain ● Instructions
Maple Spice Cherry Spice Hickory Spice Cherry Bordeaux	<ul style="list-style-type: none"> ● 1 pint primary stain ● 1 pint secondary stain ● Instructions

- Order clear top coat separately.
- Each kit covers approximately 40 sq. ft.
- Indicate species and color when ordering.
- Oak Honey also available in gallon packaging.

Care & Maintenance Putty Stick & Marker

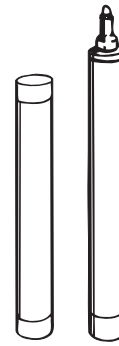

PUTTY STIK
TU MARKER
TOUCH UP KIT

- Putty stick – for filling minor dents, gouges, and scratches made during or after installation.
- Touch Up Marker – adds color to minor surface scratches.
- Available for purchase individually or together as a kit.

Decorator Door Clips

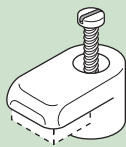

Bag A Bag C
Bag B Bag D

- For installation of customer supplied glass or decorative door insert.
- Must specify Standard Overlay (SOL) or Full Overlay (FOL) when ordering.
- Order one bag per door.
- Accommodates insert panel thickness as follows:
Bag A = 1/16" inserts
Bag B = 1/8" inserts
Bag C = 1/4" – 9/32" inserts
Bag D = 7/16" inserts

DECORATIVE HARDWARE DESCRIPTION

Timberlake Cabinet Company has chosen a wide selection of decorative knobs and pulls to compliment our cabinets.

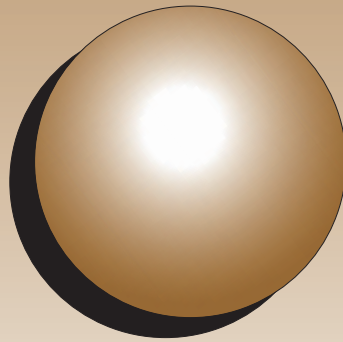

Decorative Hardware - Knobs & Pulls



BRONZE SWIRL KNOB
KNOB 3010-BZ



BRONZE SWIRL PULL
PULL 3011-BZ
5" CENTER



PEWTER OAK LEAF KNOB
KNOB 3047-P



PEWTER OAK LEAF PULL
PULL 3046-P
3" CENTER



OAK LEAF BRASS KNOB
KNOB 3016-WB



OAK BRASS LEAF CUP
PULL 3017-WB
3" OR 3-3/4" CENTER



OAK BRASS LEAF PULL
PULL 3018-WB
3" CENTER



IRON OXIDE KNOB
KNOB 3088-R



IRON OXIDE PULL
PULL 3078-R
3-3/4" CENTER



BRUSHED STEEL PULL
PULL 3071-BA
3-3/4" CENTER



FRENCH NICKEL KNOB
KNOB 3103-N



FRENCH TWIST KNOB
KNOB 3102-N



FRENCH TWIST PULL
PULL 3101-N
5" CENTER



SHELL KNOB
BURNISHED BRASS
KNOB 3113-BB



SHELL PULL • BURNISHED BRASS
PULL 3112-BB
3" CENTER



SHELL KNOB
STERLING BRASS
KNOB 3113-SB



SHELL PULL • STERLING BRASS
PULL 3112-SB
3" CENTER

Decorative Hardware - Knobs & Pulls



CONTOUR KNOB
SATIN CHROME
KNOB 3152-SC



CONTOUR PULL • SATIN CHROME
PULL 3151-SC
3" CENTER



CONTOUR FINGER PULL
SATIN CHROME
PULL 3154-SC



CONTOUR CUP PULL • SATIN CHROME
PULL 3153-SC
3" CENTER

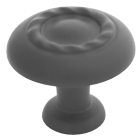

CONTOUR KNOB
FLAT BLACK
KNOB 3152-FB



CONTOUR PULL • FLAT BLACK
PULL 3151-FB
3" CENTER



CONTOUR FINGER PULL
FLAT BLACK
PULL 3154-FB

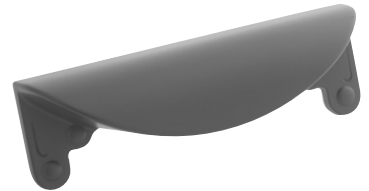

CONTOUR CUP PULL • FLAT BLACK
PULL 3153-FB
3" CENTER



PULL • BLACK NICKEL
PULL 3172-BN
3" CENTER



PULL • STERLING NICKEL
PULL 3172-SN
3" CENTER



PULL • STERLING BRASS
PULL 3172-SB
3" CENTER



BLACK NICKEL KNOB
KNOB 3173-BN



STERLING NICKEL KNOB
KNOB 3173-SN



STERLING BRASS KNOB
KNOB 3173-SB



WHITE CERAMIC
MUSHROOM KNOB
KNOB 3191-CW



WHITE CERAMIC KNOB
KNOB 3027-CW



ALMOND CERAMIC KNOB
KNOB 3027-CB



WOOD KNOB

WOOD KNOB	ITEM #
OAK NATURAL	KNOB 3191-OAK N
OAK HONEY	KNOB 3191-OAK H
OAK FROST	KNOB 3191-OAK F
OAK TOFFEE	KNOB 3191-OAK T
MAPLE NATURAL	KNOB 3191-MAPLE N
MAPLE SPICE	KNOB 3191-MAPLE S
MAPLE FROST	KNOB 3191-MAPLE F
HICKORY NATURAL	KNOB 3191-HICKORY N
HICKORY SPICE	KNOB 3191-HICKORY S
CHERRY BORDEAUX	KNOB 3191-CHERRY B
CHERRY SPICE	KNOB 3191-CHERRY S



SLOTTED STEEL PULL
PULL 3123-SC
3" CENTER



STEEL BOW PULL
PULL 3129-SC
5" CENTER