

**PANELS-FILLERS-MOLDINGS DESCRIPTION**

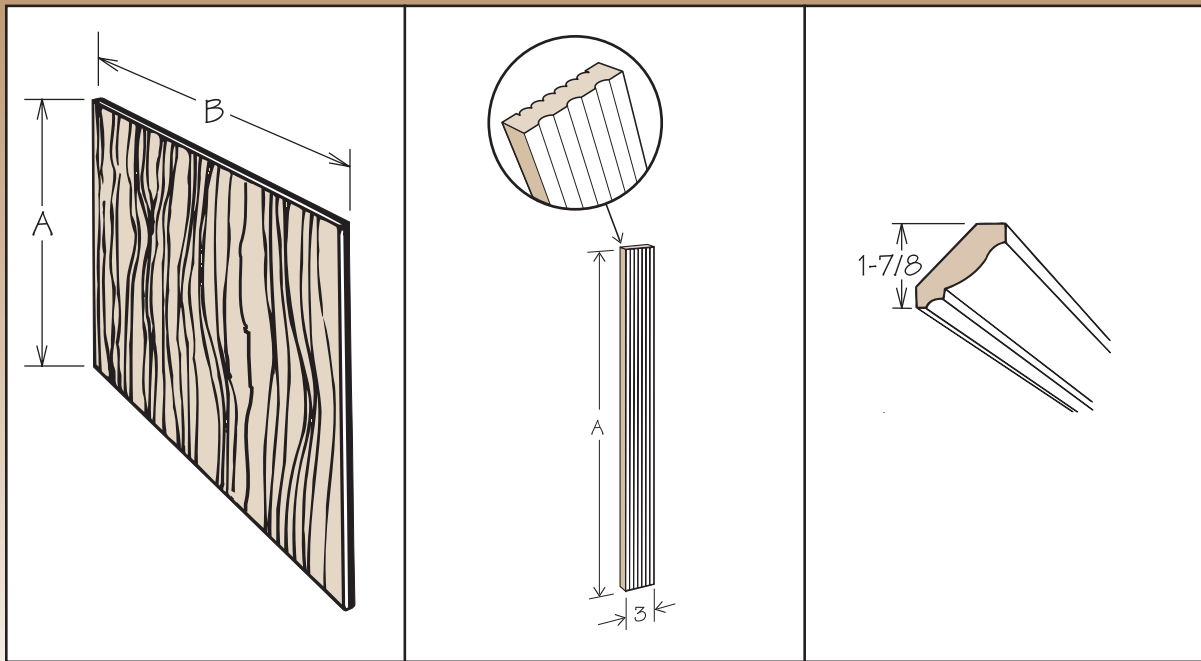

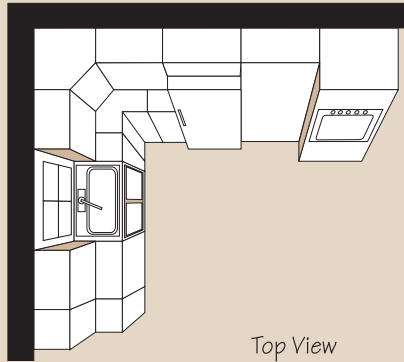

Top View

Panels

Desk End Panel

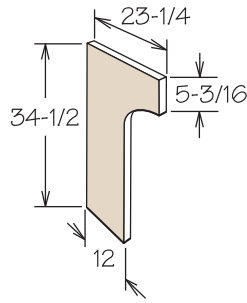

DEP

- Fully trimmable.
- 3/4" thick veneered engineered wood.
- It is recommended that QM8 be ordered to ensure proper attachment to back wall.

Dishwasher Insert Panel

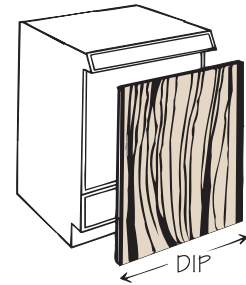

DIP

- Available in 3/16" thick veneer plywood and 3/16" roll-coated industrial substrate.
- 1 fully trimmable piece.
- 23-7/8" x 30-1/8".

Drop-In Range Front

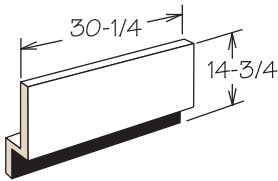

DORF30

- 1/2" thick veneered engineered board.
- Finished on both sides.
- Trimmable in height and width.
- Toekick is attached and can be removed for alignment.

Dishwasher Return

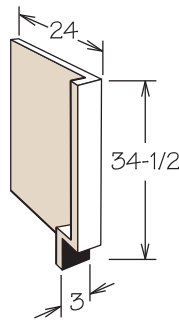

DWR3 L&R

● TPS

- Solid wood front.
- Side finished to match cabinet side.
- Specify left or right (right shown).
- Trimmable down to 1" in width.
- Attaching blocks included.

Sink/Vanity Front Return

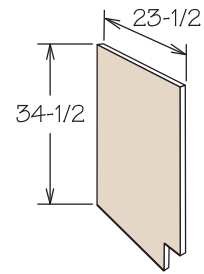

SFR L&R

● TPS

- Side finished to match cabinet finish.
- 1/2" thick.
- Attaching blocks included.

**Sink/Vanity Front Floor**

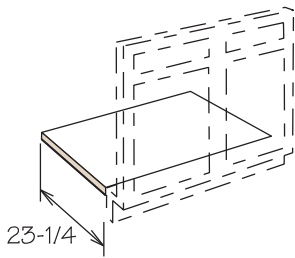

FL24  
FL36  
FL36x36  
FL48  
FL48x48  
FL60  
FL72

- FL36x36 can be cut to fit CSF36 – depth of 36-1/4".
- FL48x48 can be cut to fit CSF42 – depth of 47-3/4".
- 1/2" thick and finished to match cabinet interior.
- 1/2" oversize in width.

**Base End Panel**

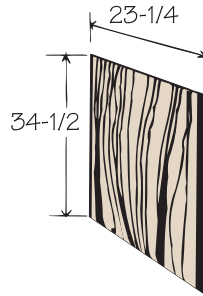

BEP34 WD  
BEP34 PRT

- Print only available in white.
- White door styles only available in 3/16" engineered wood (PRT).
- Wood grain door styles use 3/16" thick veneered plywood (WD).

**Wall End Panel**



WEP30 WD  
WEP42 WD  
WEP30 PRT\*\*  
WEP42 PRT\*\*

- WEP30 A = 30-1/8".
- WEP42 A = 42-1/8".
- 3/16" thick veneered plywood (WD).
- \* **Not available in Maple Frost or Oak Frost.**
- \*\* Print (PRT) available in white only.

**Tall End Panel**

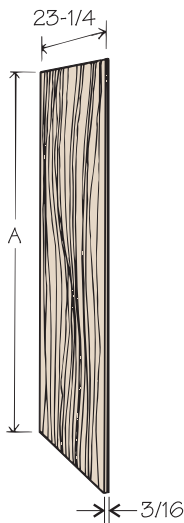

TEP84 WD    TEP84 PRT\*  
TEP96 WD    TEP96 PRT\*

- 3/16" thick veneered plywood (WD).
- TEP84 A = 84".
- TEP96 A = 96".
- \* Print (PRT) available in white only.

**Refrigerator Returns**

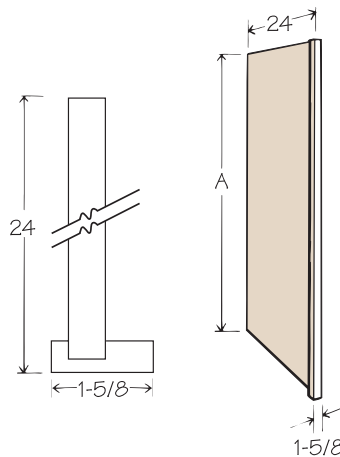

RR84  
RR96

● **TPS**

- Solid wood front.
- Return (side) is 1/2" thick.
- Side finished to match cabinet side.
- Inside is an interior print.
- Invert for left or right.
- RR84 A = 84".
- RR96 A = 96".

**Wood Tall End Panel**

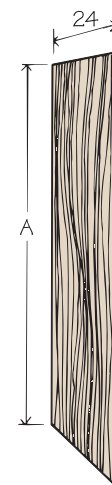

WTEP84  
WTEP96

- 3/4" engineered wood.
- Veneer finished on both sides.
- Edge banded along both long sides of panel.
- White door styles are melamine.
- WTEP84 A = 84".
- WTEP96 A = 96".

**Finished Paneling**

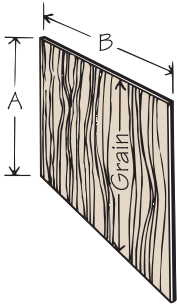

FP4834 WD  
 FP4896 WD  
 FP9634 WD\*  
 FP4834 PRT\*\*  
 FP4896 PRT\*\*

- Trimmable 3/16" thick paneling.
  - FP4834 A = 34-1/2" B = 48".
  - FP4896 A = 96" B = 48".
  - FP9634\* A = 34-1/2" B = 96".
- \* FP9634 not available in white.  
 \*\* Print (PRT) only available in white.

**Finished Shelving**

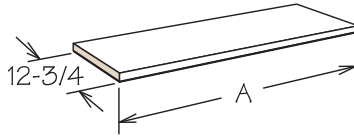

FS4812  
 FS6012  
 FS7212

- Solid 3/4" thick wood.
- FS4812 A = 48-1/4".
- FS6012 A = 60-1/4".
- FS7212 A = 72-1/4".

**Blind Corner Closure**

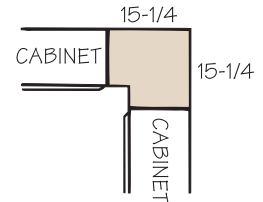
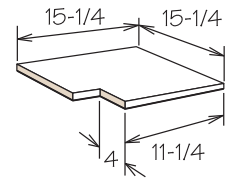

BLC1515

- 1/2" thick.

**Decorator Matching Appliance Panels**

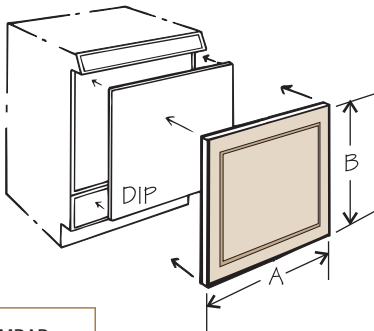

DMDAP  
 DMDAPT

|              | A        | B       |
|--------------|----------|---------|
| DMDAP (SOL)  | 9-7/8"   | 16"     |
| DMDAP (FOL)  | 20-9/16" | 17-1/2" |
| DMDAPT (SOL) | 9-7/8"   | 17-1/2" |
| DMDAPT (FOL) | 20-9/16" | 23-7/8" |

- Attaches directly to dishwasher insert panel (DIP).
- Order DIP separately.
- FOL styles have 1 panel. SOL styles have 2 panels.
- Consult your parts directory for other door size availability.
- DMDAPT for use with appliances that have tall front panels.

Note: DMDAPT may require heavy duty spring on dishwasher door. Check manufacturer's specifications for details.

**Decorator Matching Doors Base Cabinets**

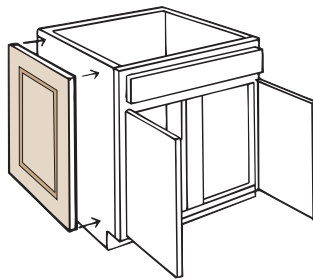

DMDB

- Attaches directly to side of cabinet.
- Matches style and color of cabinet doors.
- Panels extend out 1/2".
- We recommend using a finished panel with DMD's.

**Decorator Matching Doors Wall Cabinets**

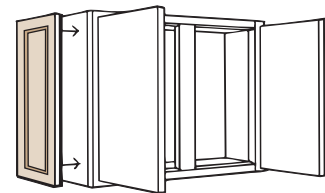

DMDW18  
 DMDW24  
 DMDW30  
 DMDW36  
 DMDW42

- Attaches directly to side of cabinet.
- Matches style and color of cabinet doors.
- Panel extends out 1/2".
- We recommend using a finished panel with DMD's.

**Decorator Matching Doors  
Vanity Cabinets**

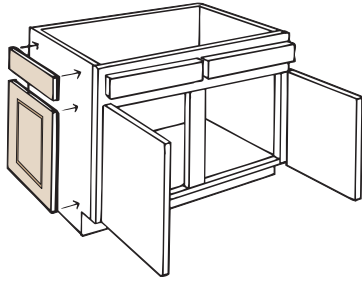

DMDV

- Attaches directly to side of cabinet.
- Matches style and color of cabinet doors.
- Panels extend out 1/2".
- We recommend using a finished panel with DMD's.

**Decorator Matching Doors  
Tall Cabinets**

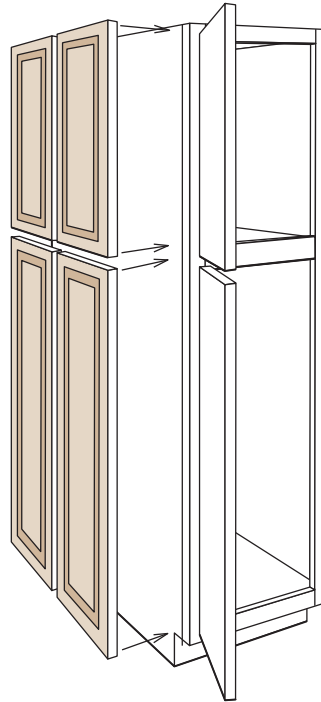

**Decorator Matching Doors  
Range Hoods**

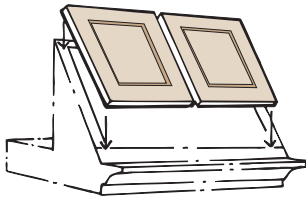

DMDRH30  
DMDRH36

- For use with RH30 and RH36.
- 2 doors mount directly to range hood.
- Panels extend out 1/2".

DMDT8412  
DMDT8424  
DMDT9012  
DMDT9024  
DMDT9612  
DMDT9624

- For pantry/oven cabinets.
- Attaches directly to side of cabinet.
- Matches style and color of cabinet doors.
- Panels extend out 1/2".
- 24" deep receive 4 doors and 12" deep receive 2 doors.
- We recommend using a finished panel with DMD's.

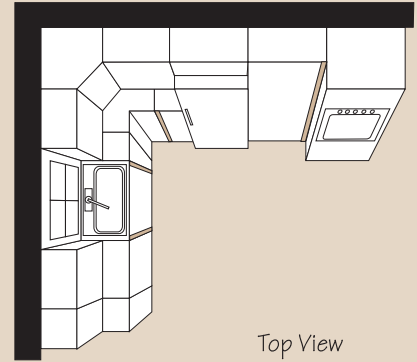

Top View

**Fillers**

**Base Corner Filler**

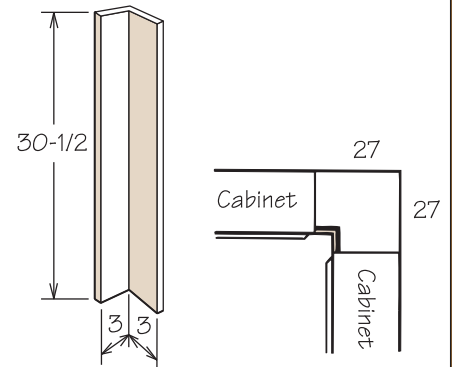

BCF27

- 3/4" thick solid wood.
- TKB14 toekick included.

Universal Filler

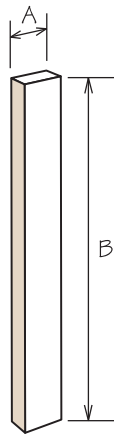

UF3  
UF6  
UF342  
UF642  
OVSF3  
OVSF6  
OVSF396  
OVSF696

- Order TK814 toekick separately.
- 3/4" thick solid wood.
- UF3 A = 3" B = 30-1/2".
- UF6 A = 6" B = 30-1/2".
- UF342 A = 3" B = 42-1/8".
- UF642 A = 6" B = 42-1/8".
- OVSF3 A = 3" B = 80".
- OVSF6 A = 6" B = 80".
- OVSF396 A = 3" B = 92".
- OVSF696 A = 6" B = 92".

Base Overlay Filler

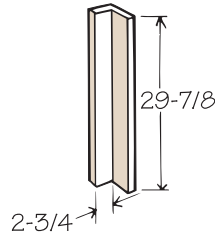

BOF3X3

- White Thermo Foil door styles only.
- All edges are finished.
- Use over BCF27.
- Two pieces mitered on one edge to allow trimming.

Tall Overlay Filler

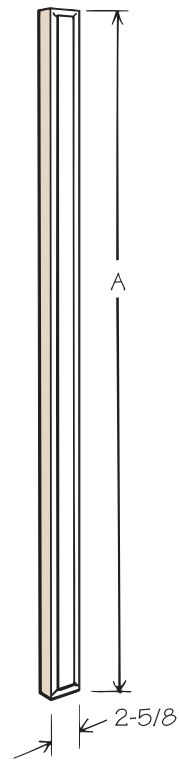

TOF384  
TOF390  
TOF396

- Available in FOL white Thermo Foil door styles only.
- All edges are finished.
- TOF384 A = 79-3/8"
- TOF390 A = 85-3/8"
- TOF396 A = 91-3/8"

Must be mounted to a universal filler. Filler must be ordered separately.

Overlay Filler

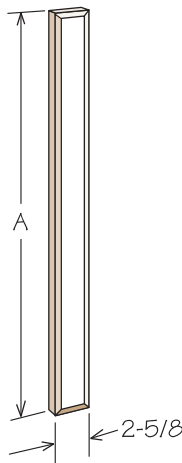

WOF315 BOF3  
WOF318 VOF3  
WOF324  
WOF330 TOF384  
WOF336 TOF390  
WOF342 TOF396

- Available in FOL white Thermo Foil door styles only.
- Outside profile matches door.
- Indicate style when ordering.

| DIMENSIONS | A       | DIMENSIONS | A       |
|------------|---------|------------|---------|
| WOF315     | 14-1/2" | BOF3       | 29-1/2" |
| WOF318     | 17-1/2" | VOF3       | 26-1/2" |
| WOF324     | 23-7/8" |            |         |
| WOF330     | 29-1/2" | TOF384     | 79-3/8" |
| WOF336     | 35-1/2" | TOF390     | 85-3/8" |
| WOF342     | 41-1/2" | TOF396     | 91-3/8" |

Must be mounted to a universal filler. Filler must be ordered separately.

Wall Overlay Filler  
5-5/8" Wide

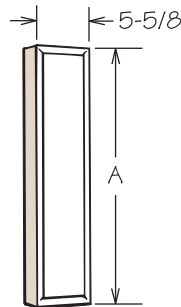

WOF630  
WOF636  
WOF642

- Available in FOL white Thermo Foil door styles only.
- All edges are finished.
- WOF630 A = 29-1/2"
- WOF636 A = 35-1/2"
- WOF642 A = 41-1/2"

Must be mounted to a universal filler. Filler must be ordered separately.

## Fluted Beaded Filler (Reversible)

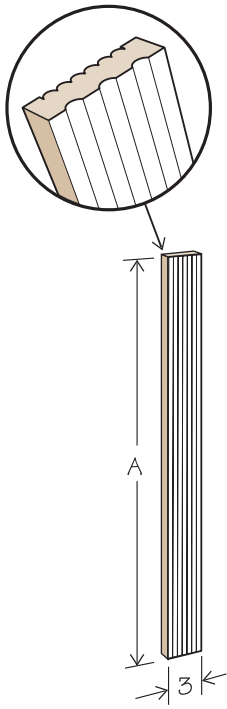

FBF3  
 FBF342  
 FBF384  
 FBF396

- Reversible filler is fluted on one side and beaded on the other.
- Finished all sides.
- Trimmable.
- 3/4" thick solid wood.
- Designer note: Ensure correct side is facing out when installed.

FBF3    A = 30-1/2"  
 FBF342    A = 42-1/8"  
 FBF384    A = 84"  
 FBF396    A = 96"

## Fluted Rosette Block

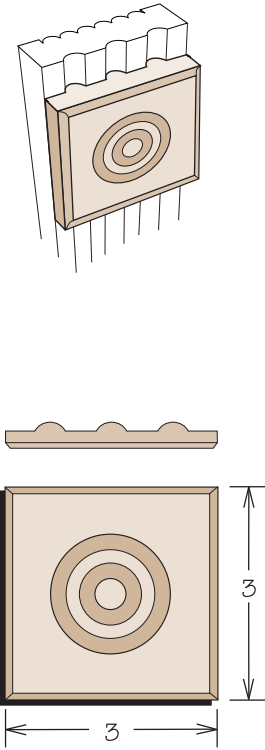

FB3X3 ROSETTE

- Apply to FLUTED side of reversible filler.
- Solid wood.

## Beaded Rosette Block

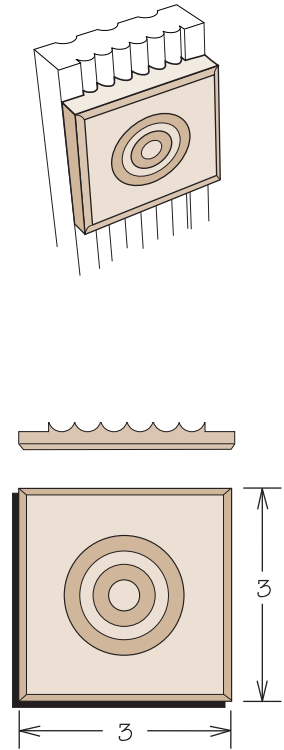

BB3X3 ROSETTE

- Apply to BEADED side of reversible filler.
- Solid wood.

Fluted Aster Block

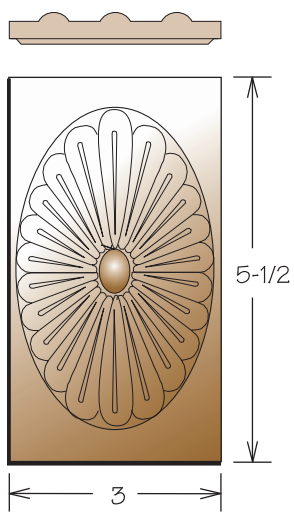
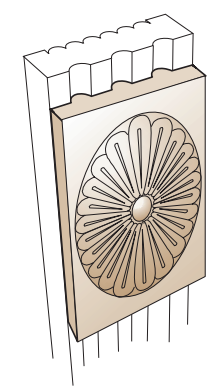

FB 3X6 ASTER

- Apply to FLUTED side of reversible filler.
- Solid hardwood with carved applique.

Beaded Aster Block

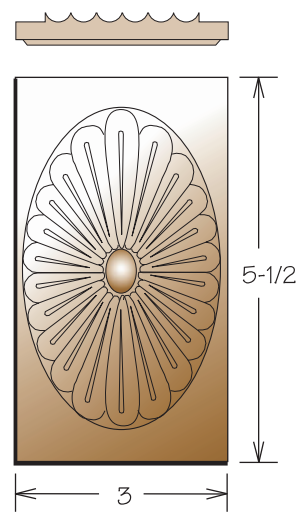
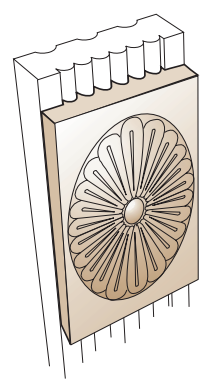

BB 3X6 ASTER

- Apply to BEADED side of reversible filler.
- Solid hardwood with carved applique.

Fluted Plinth Block

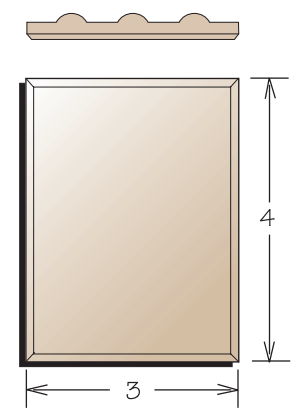
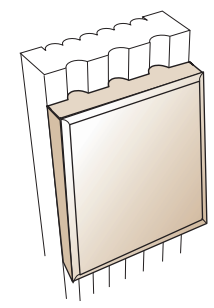

FB 3X4 PLINTH

- Apply to FLUTED side of reversible filler.
- Solid hardwood.

## Beaded Plinth Block

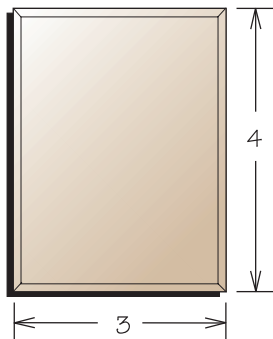
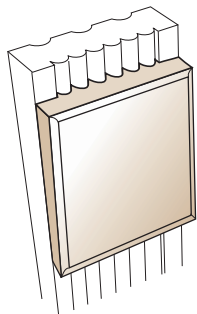

BB 3X4 PLINTH

- Apply to BEADED side of reversible filler.
- Solid hardwood.

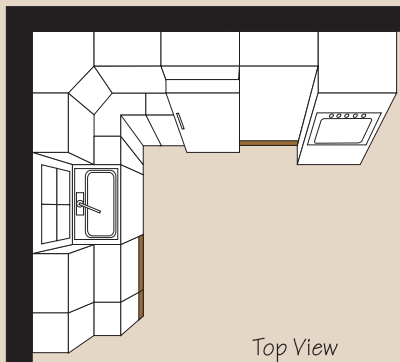

Top View

## Toekicks

## Base Toekick

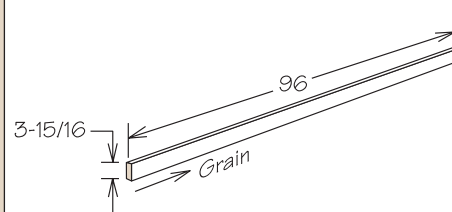

BTK8 WD  
BTK8 PRT

- 3/16" thick veneer plywood or white roll coat.
- BTK8 Print is 3/16" printed material.
- Applies over toekicks to match cabinet color.

## Toekick Cap

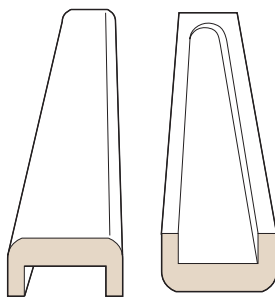

TK Cap WD  
TK Cap Plastic

- Solid hardwood (TK Cap).
- Finish matches cabinet exterior.
- Apply to end of standard height toekick to finish run.
- TK Cap Plastic color matched to coordinate with most finishes.
- Hickory door styles use oak.

## Trimmable Toekick Assembly

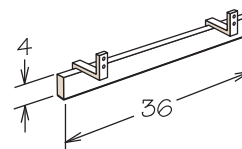

TKA36T

- For use with OV and UT fronts and doors.
- Trimmable to any size.
- Includes brackets and screws for attachment to fronts.